

CAD FILE:

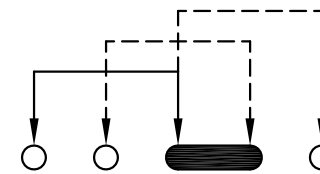

SCHEMATIC (SHORTING)

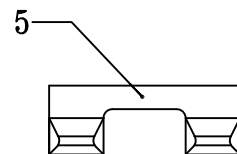
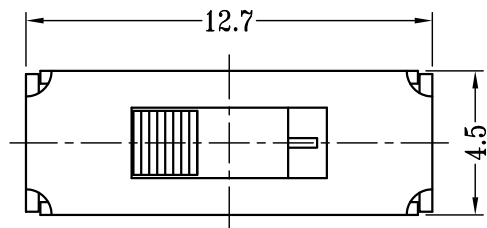
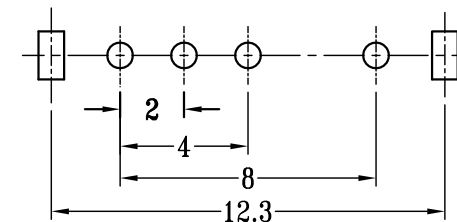
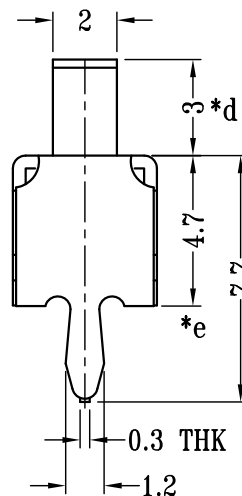
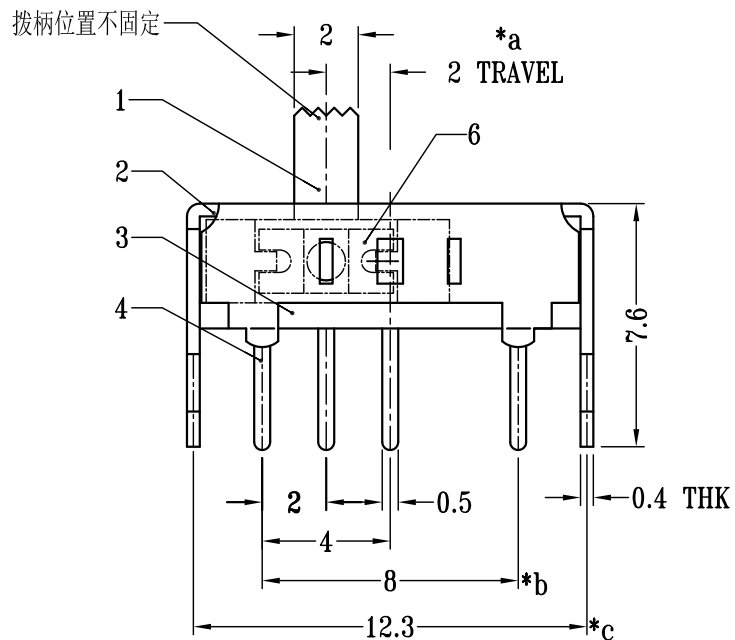

P.C.B LAYOUT
BOTTOM VIEW

注：“*”表示关键尺寸(5个).

NO.	PARTS	MATERIALS	Q'TY	FINISH	TOLERANCE UNLESS SPECIFIED				
8									
7									
6	SPRING PLATED	PBS STRIP	2	NATURAL	WITHIN 1.5mm : ±0.1mm	A	2019-8-13	初版	王远杰
5	CONTACT CLIP	PBS C5210R-EH	1	Ag CLAD	OVER 1.5mm : ±0.2mm	ISSUE	DATE	DESCRIPTIONS OF REVISION	APPD.
4	TERMINAL	BRASS STRIP	4	Ag PLATED	TITLE : VERTICAL SLIDE SWITCH			UNIT : mm	DRWG NO.: HQ-DR-SS13D01G3-00
3	BASE	PHENOLIC RESIN	1	NATURAL	MODEL: SS13D01G3-NF-Cs-II			SCALE: 4:1	DWN. 王远杰 2019-8-13
2	FRAME	STEEL STRIP	1	Ni PLATED	 东莞市铭标电子科技有限公司 Ming Mark Electronic Technology Co., Ltd.			CHK'D	朱明华 2019-8-13
1	KNOB	PA66	1	BLACK				APPD.	
					RoHS				