

REV.	Q'TY	ECN. NO.	APR.	DATE
X0	--	FIRST_DRAWING		
X1	1			

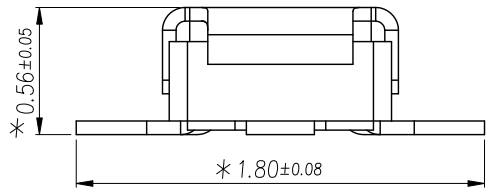

SECTION M-M
SCALE 30:1

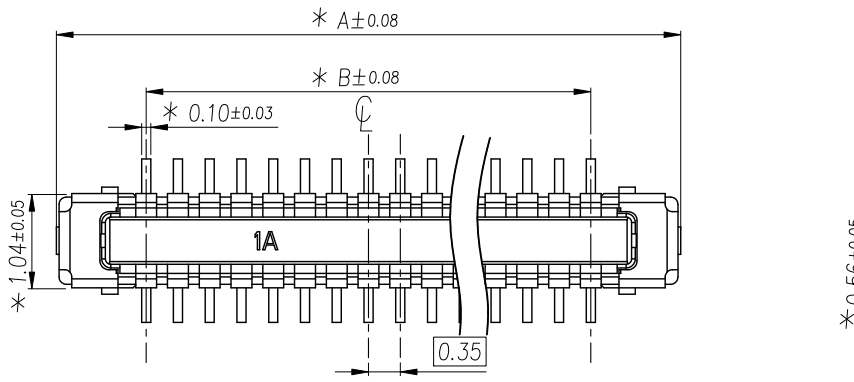
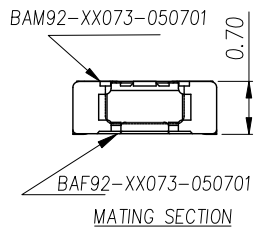

NOTES:

- 1.) PRODUCT SPECIFICATIONS:
 - 1-1.VOLTAGE RATING: 60V AC/DC
 - 1-2.CURRENT RATING: 0.3A/POS,PEG RATING 5A .
 - 1-3.INSULATION RESISTANCE: 100 MEG.OHM MIN.
 - 1-4.WITHSTANDING VOLTAGE: 250V AC FOR 1 MINUTE
 - 1-5.CONTACT RESISTANCE: 50 MILL.OHM MAX
 - 1-6.THE DIMENSION MARKED "*" SHOULD BE CHECKED BY QC, DIMENSION MARKED ☆ MUST MAKE CPK STATISTIC;
 - 1-7.OPERATION TEMPERATURE: -55° TO +85°
 - 1-8.MATING FORCE: 100g Max./POS.
 - 1-9.UNMATING FORCE: 15g Min./POS.
 - 1-10.DURABILITY: 30 CYCLES
- 2.) PART NO:

BAM92-XX073-050701

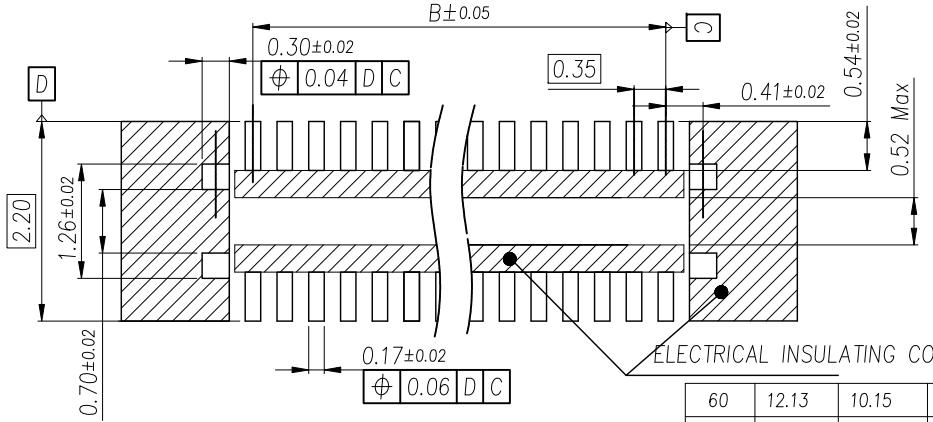
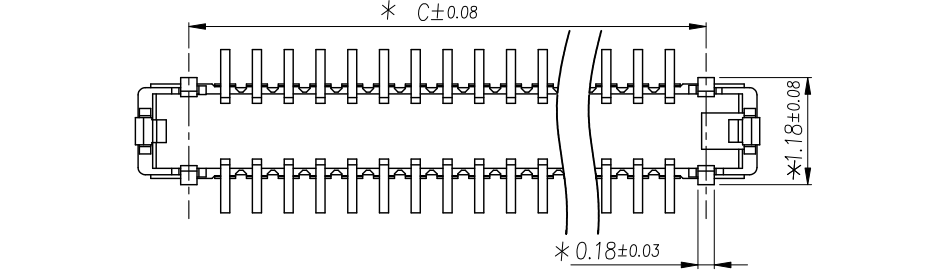
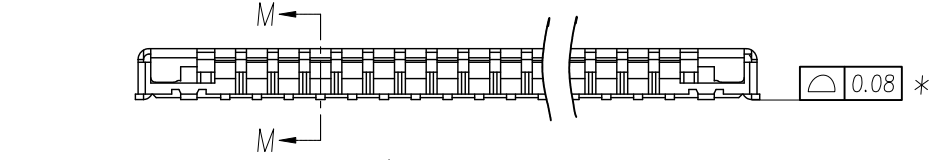
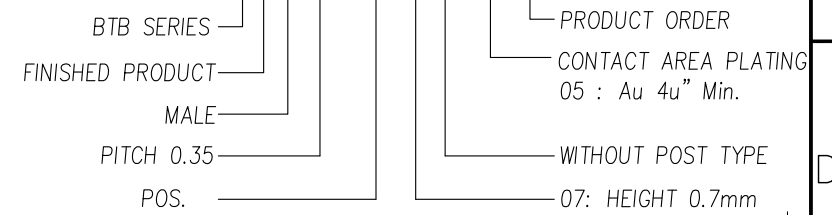

RECOMMENDED PCB LAYOUT

TABLE:

60	12.13	10.15	10.95	◎
50	10.38	8.40	9.20	◎
40	8.63	6.65	7.45	◎
38	8.28	6.30	7.10	◎
30	6.88	4.90	5.70	◎
10	3.38	1.40	2.20	◎
POS.	A	B	C	Available

NO.	PART	MATERIAL	FINISH
A	BASE INSULATOR	LCP	BLACK COLOR
B	CONTACT TERMINAL	Copper alloy	Contact: Au 4u" MIN over Ni 50u" MIN Lead: Au 2u" Min over Ni 50u" MIN
C	PEG	Copper alloy	Contact: Au 4u" MIN over Ni 50u" MIN Lead: Au 2u" Min over Ni 50u" MIN

东莞市铭标电子科技有限公司

DIMENSION IN mm		APR.		TITLE: 0.35PITCH 0.7H BTB CONN.	
TOLERANCE UNLESS OTHERWISE SPECIFIED		CHK.		DWG NO. BAM92-00073-000701	
.X±0.05	X.*± 1.5°	DRA. HARBOR 2019.11.12		SIZE A4	SHEET 1/2
.XX±0.03	.X.*± 1.0°	PROJ.		SCALE 3:1	REV. X1
.XXX±0.02	.XX.*± 0.5°				

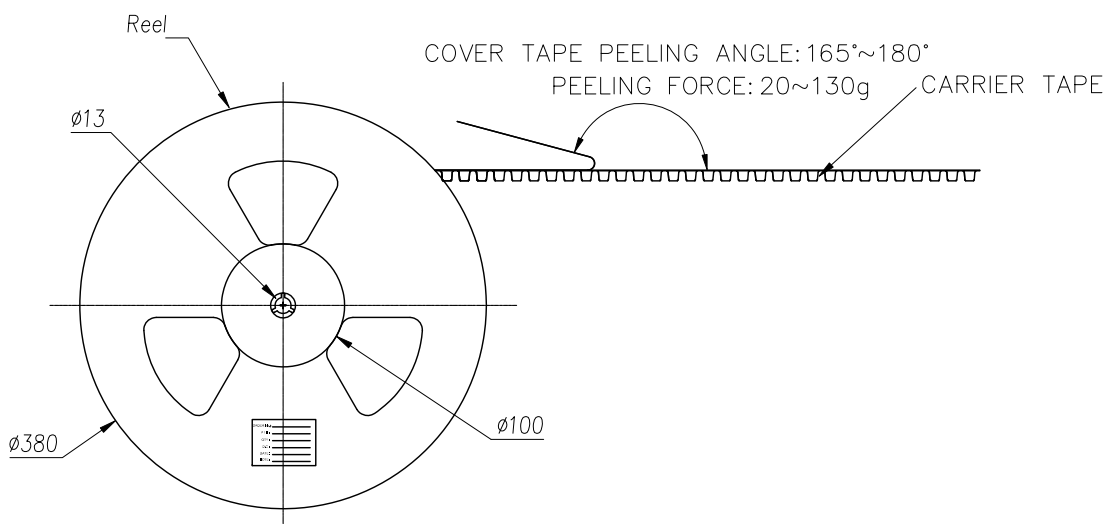
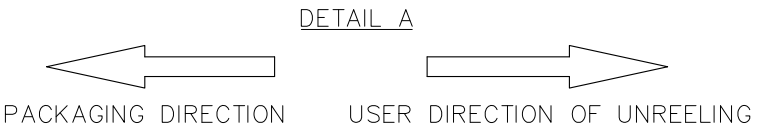
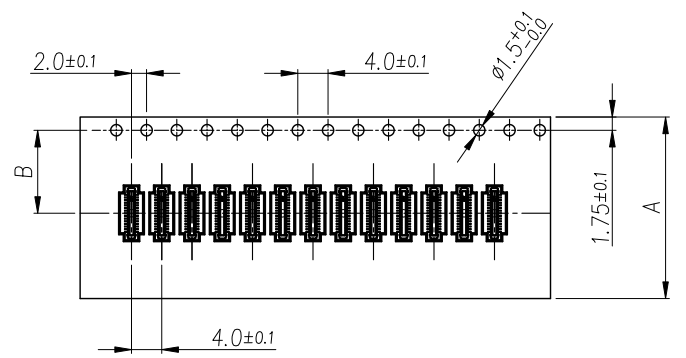
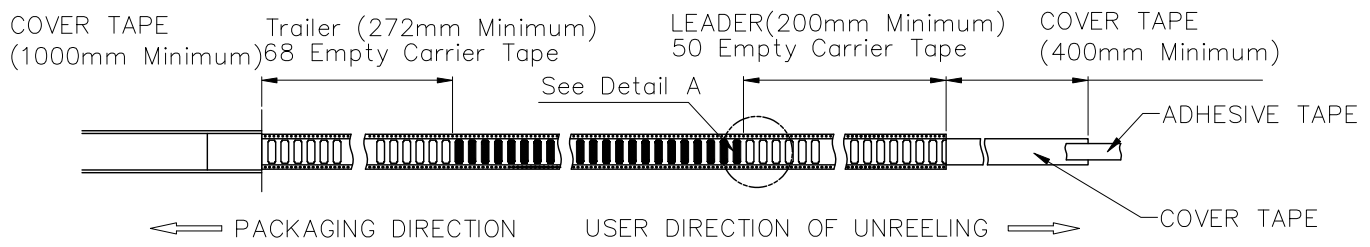

60	24.00	11.50	15000	15	225000	400*400*335
50	24.00	11.50	15000	15	225000	400*400*335
40	16.00	7.50	15000	15	225000	400*400*335
38	16.00	7.50	15000	15	225000	400*400*335
30	16.00	7.50	15000	15	225000	400*400*335
10	16.00	7.50	15000	15	225000	400*400*335
POS NO	DIM A	DIM B	QTY/REEL	REEL/CARTON	QTY/CARTON	CARTON SIZE

DIMENSION IN mm		东莞市铭标电子科技有限公司									
TOLERANCE UNLESS OTHERWISE SPECIFIED											
.X±0.05	X.*± 1.5'	APR.	TITLE: 0.35PITCH 0.7H BTB CONN.								
.XX±0.03	.X.*± 1.0'	CHK.	DWG NO. BAM92-00073-000701								
.XXX±0.02	.XX.*± 0.5'	DRA. HARBOR 2019.11.12	<table border="1"> <tr> <td>PROJ.</td> <td></td> <td>SIZE A4</td> <td>SHEET 2/2</td> </tr> <tr> <td colspan="2"></td> <td>SCALE 3:1</td> <td>REV. X1</td> </tr> </table>	PROJ.		SIZE A4	SHEET 2/2			SCALE 3:1	REV. X1
PROJ.		SIZE A4	SHEET 2/2								
		SCALE 3:1	REV. X1								