



东莞市铭标电子科技有限公司

MINGBIAO ELECTRONICS CO., LTD

# 承 认 书

APPROVE SHEET

客户名称 Customer: \_\_\_\_\_

品 名 Part name: Tact swi tch

型 号 Part Number: TVBF35

Design/ Date	Check/Date	Review/Date	Approval/Date

## 贵公司承认印 Approval signatures

Approval/Date	Remark

Send us a copy of reference , thank you! 日期 Date:

**地址:** 广东省东莞市长安镇沙头社区猫山东路 101 号

**Add:** Dongguan City, Guangdong Province, Chang'an Town, Sand head community The cat shandong road, No. 101

**Ntel:** 0769-81581583

### P. C. B MOUNTING PATTERN DIMENSION

the following soldering are recommended  
for reflow soldering

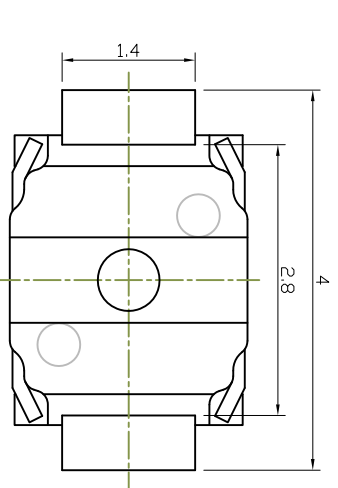
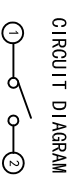
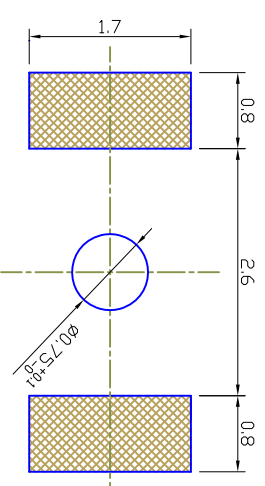
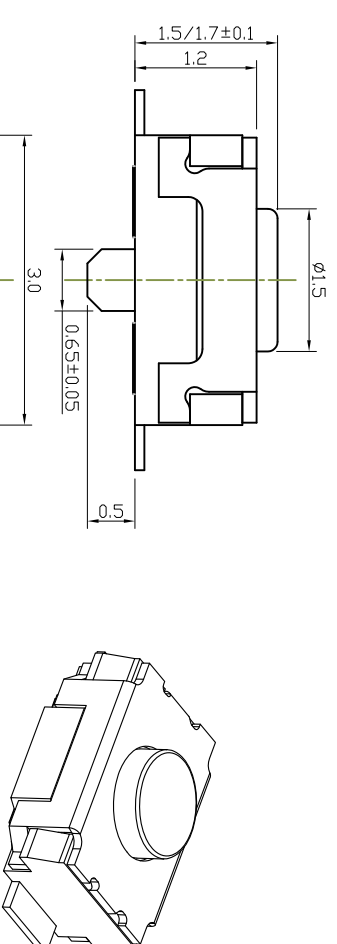

### 技术参数

NO	项目	参数	数量
1	额定电流	50mA 12V DC	
2	接触电阻	$\leq 100m\Omega$	
3	按压力	160±50gf	
4	行程	0.15±0.05mm	
5	绝缘电阻	>100M $\Omega$	
6	抗电强度	AC 250V 50Hz 1Min	
7	寿命	100,000 cyc	

按钮	1	黑色	LCP
金属盖子	1	本色	不锈钢
薄膜	1	黄色	聚酰亚胺
簧片	2	本色	不锈钢覆银
底座	1	白色	LCP
端子	2	银白色	磷铜镀银
零部件名称	数量	颜色	材料

符合 ROHS标准

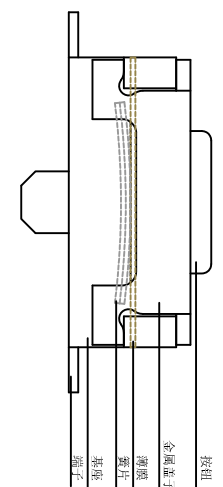
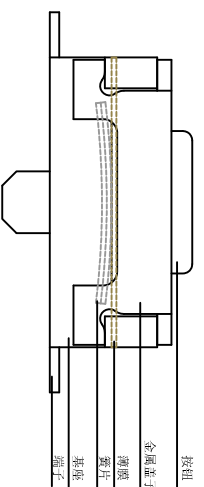

更改文件号	标记	日期	变更内容	担当	审核	批准	角度	公差
							30°<L	±0.30
							10°<L≤30	±0.20
							5°<L≤10	±0.15
							L≤5	±0.10
								±2°

东莞市铭标电子科技有限公司  
Ming Mark Electronic Technology Co., Ltd.

设计审核

20130322

RoHS

产品名称	产品型号
两脚小小龟 3.0*2.7	TVBF35-A

1. General specification 基本事项
1.1 Switch action 开关种类: Tact Switch 轻触开关
1.2 Switch rating 最大额定值: DC 12V, 50mA
1.3 Operation temperature range 使用温度试验范围: -20°C~+70°C
1.4 Preservative temperature range 保存温度范围: -40°C~+85°C
1.5 Appearance and dimensions : See outside drawing page 外形尺寸: 见外形尺寸图
1.6 Standard condition :Unless otherwise specified ,the test and measurements shall be carried out as follows :试验、测定状态 Ambient temperature 温度: 5~35°C Relative humidity 相对湿度: 45~85% Air pressure 气压: 86~106kPa(860~1060mbar) However ,if doubt arises on the decision based on the measured Values under the above-mentioned conditions ,the following conditions be employed: 但是在对判定产生疑义时,按下述状态实施: Ambient temperature 温度: 20±2°C Relative humidity 相对湿度: 65±5% Air pressure 气压: 86~106kPa(860~1060mbar)

## 2. Performance 性能

### 2.1 Electrical characteristics 电气性能

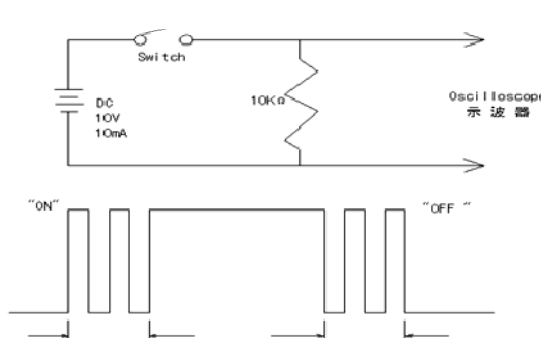
Item 项目	Test condition 测试条件	Performance 规格
2.1.1 Contact Resistance 接触电阻	Push force: (Operation force)X2。 测定时的负荷: 操作方向动作力基准值的 2 倍 Measurement tool: Contact resistance meter 测定器: 微电流接触电阻计 (1kHz,20mV,5~50mA)	100mΩ max. 100 毫欧以下。
2.1.2 Insulation Resistance 绝缘电阻	DC 250V(Between terminals) frame for 1 minute. 不相接的两端子间、端子与塑胶间施加 DC250V 电压,持续 1 分钟测量	100MΩ min. 100 兆欧以上。
2.1.3 Withstand Voltage 耐电压	AC 250V (Between terminals) frame for 1 minute. 不相接的两端子间、端子与塑胶间施加 AC250V 电压,持续 1 分钟测量	No insulation destruction 无绝缘破坏
2.1.4 Bouncing 触点抖动	Operation speed:3~4times/s 操作速度: 每秒 3~4 次 	ON: 3ms max 以下 OFF: 8ms max 以下

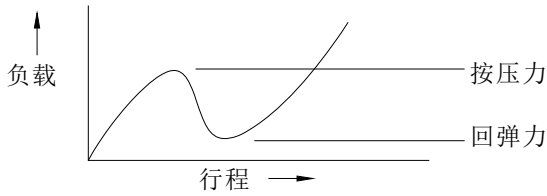
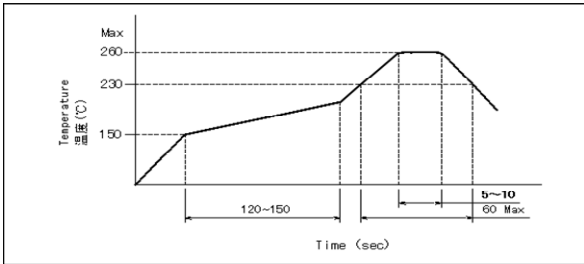
2.2 Mechanical Characteristics 机械性能			
Item 项目	Test condition 测试条件	Performance 规格	
2.2.1 Operations Force 动作力	Push by recommended operating condition. 测量时在开关的顶端的面中央、按开关动作方向均匀施加静负荷。 	Push force 按压力 $1.57 \pm 0.47\text{N}$ ( $160 \pm 50\text{gf}$ ) Return force 回弹力 $0.49\text{N}$ ( $50\text{gf}$ 最小)	
2.2.2. Travel to closure 运作行程	Push by recommended operating condition $F=(\text{Operation force}) \times 2$ 在开关的顶端的面中央沿开关动作方向施加2倍操作力测量行程，测量仪器的顶端应平。	$0.15 \pm 0.05\text{mm}$	
2.2.3 Push strength 按压强度	30N (3Kgf) for 1 minute 在开关驱动器器件顶端中央，在按压力方向加 30N (3Kgf) 压力，作用 60 秒。	No damage(Electrical and mechanical) 无异常 (电气、机械性能)	
2.2.4 Vibration test 耐振性	1) Amplitude 全振幅: 1.5mm 2) Sweep rate: 10-55-10Hz for 1 minute 扫描速度: 10-55-10Hz 1分钟 3) Sweep method: Logarithmic frequency sweep rate 扫描方式: 对数频率扫描速度 4) Vibration direction : X、Y、Z (3 directions) 振动方向: X、Y、Z (3方向) 5) Time: Each direction 2 hours (Total 6 hours) 时间: 每个方向2个小时 (共6小时)	No.2.1 and 2.2.1 to 2.2.2 shall be satisfied 满足 2.1 项和 2.2.1 至 2.2.2 项。	
2.2.5 SOLDER HEAT RESISTANCE 回流焊接热试验	REFLOW SOLDERING: 	Without deformation of case or excessive looseness of electrical properties 本体无变形，能满足电气、机械性能。	
2.2.6 Solderbility 可焊性	After sprated flux 涂上助焊剂后 temperature: $245 \pm 5^\circ\text{C}$ 温度: $245 \pm 5^\circ\text{C}$ Soldering time: $3 \pm 0.5\text{sec}$ 焊接时间: $3 \pm 0.5$ 秒	90% or more of surface area of the portion immersed in solder shall be covered by new solder 90%或更多的浸焊面积能被焊锡覆盖	

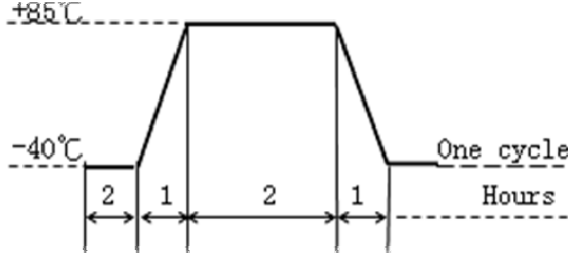
2.3 Climatic characteristics 耐候性能		
Item 项目	Test condition 测试条件	Performance 规格
2.3.1 Cold test 耐寒性	1) Temperature: $-40\pm 2^{\circ}\text{C}$ 温度: $-40\pm 2^{\circ}\text{C}$ 2) Duration of test: 96h 持续时间: 96 小时 3) Take off a drop water 去掉水珠 4) Standard conditions after test: 1h 试验后的放置条件: 1 小时	Contact resistance : $100\text{m}\Omega$ max 接触电阻: $100\text{m}\Omega$ 以下 Insulation resistance: $100\text{M}\Omega$ min 绝缘电阻: DC. 250V, 大于 $100\text{M}\Omega$ Withstand voltage :No. destruction. 耐电压: 无绝缘破坏。 No. 2.2.1 to 2.2.2 shall be satisfied 满足 2.2.1 到 2.2.2 项。
2.3.2 Heat test 耐热性	1) Temperature: $80\pm 2^{\circ}\text{C}$ 温度: $80\pm 2^{\circ}\text{C}$ 2) Duration of test: 96h 持续时间: 96 小时 3) Standard conditions after test :1h 试验后的放置条件: 1 小时	Contact resistance : $100\text{m}\Omega$ max 接触电阻: $100\text{m}\Omega$ 以下 Insulation resistance: $100\text{M}\Omega$ min 绝缘电阻: DC. 250V, 大于 $100\text{M}\Omega$ Withstand voltage :No. destruction. 耐电压: 无绝缘破坏。 No. 2.2.1 to 2.2.2 shall be satisfied 满足 2.2.1 到 2.2.2 项。
2.3.3 TEMPERATURE CYCLIG TEST 温度交变试验	According to following figure, after 5cycles, test after keeping in normal condition for 30min. 如图示环境中, 循环 5 次后, 放置在正常环境中, 1 小时 后进行测量。 	Contact resistance : $100\text{m}\Omega$ max 接触电阻: $100\text{m}\Omega$ 以下 Insulation resistance: $100\text{M}\Omega$ min 绝缘电阻: DC. 250V, 大于 $100\text{M}\Omega$ Withstand voltage :No. destruction. 耐电压: 无绝缘破坏。 No. 2.2.1 to 2.2.2 shall be satisfied 满足 2.2.1 到 2.2.2 项
2.3.4 Humidity test 耐湿性	1) Temperature: $60\pm 2^{\circ}\text{C}$ 温度: $60\pm 2^{\circ}\text{C}$ 2) Relative humidity: 90~95% 相对湿度: 90~95% 3) Duration of test: 96h 持续时间: 96 小时 4) Take off a drop water 去掉水珠 5) Standard conditions after test: 1h 试验后的放置条件: 1 小时	Contact resistance : $200\text{m}\Omega$ max 接触电阻: $200\text{m}\Omega$ 以下 Insulation resistance: $100\text{M}\Omega$ min 绝缘电阻: DC. 250V, 大于 $100\text{M}\Omega$ Withstand voltage :No. destruction. 耐电压: 无绝缘破坏。 No. 2.2.1 to 2.2.2 shall be satisfied 满足 2.2.1 到 2.2.2 项

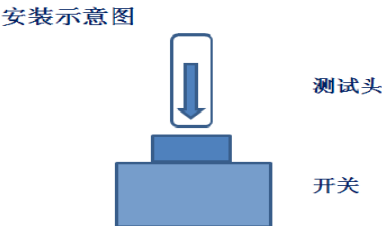
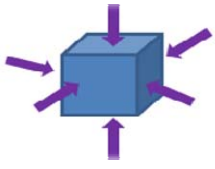
Item 项目	Test condition 测试条件	Performance 规格
2.3.5 Endurance (switching) action 耐久特性(开关寿命)	1) Operation speed: 1time/s 动作速度: 2次/秒 2) Push force: Maximum value of operation force 按力: 动作力规格值的上限 3) Operation number: 100, 000 times 动作次数: 100, 000次  安装示意图 	Contact resistance : 200mΩ max 接触电阻: 200 mΩ 以下 Bouncing : 20 ms max 触点抖动: 20 毫秒以下 Insulation resistance: 100MΩ min 绝缘电阻: DC. 250V, 大于 100MΩ Withstand voltage :No. destruction. 耐电压: 无绝缘破坏。 Variations rate of operation force shall be within ±30% to the value before testing 动作力的变化范围在初始值的±30%以内 2.2.2 shall be satisfied 满足 2.2.2 项
2.3.6 Withstand H2S 耐 H2S	1) Density: 3±1ppm 浓度: 3±1ppm 1) Temperature: 40±2℃ 温度: 40±2℃ 2) Relative humidity:90~95% 相对湿度: 90~95% 3) Duration of test: 12h 持续时间: 12 小时 4) Standard conditions after test:1h 试验后的放置条件: 1 小时	Contact resistance : 200mΩ max 接触电阻: 200 mΩ 以下 Insulation resistance: 100MΩ min 绝缘电阻: DC. 250V, 大于 100MΩ Withstand voltage :No. destruction. 耐电压: 无绝缘破坏。 No.2.2.1 to 2.2.2 shall be satisfied 满足 2.2.1 到 2.2.2 项
2.3.7 Salt mist 雾实验	At 5% Nacl liquor for 24 hours depend on 35℃, after washing ,keep in normal condition. 5% 的 Nacl 溶液, PH 值: 6.5~7.2, 在 35℃的条件下喷雾。铜材 24 小时, 铁材 8 小时。用清水洗干净后并在室温下晾干	No remarkable corrosion shall be recognized in metal part. 在金属件上没有腐蚀斑点。
2.3.8 Shock 耐冲击性	Peak acceleration: 500m/S <sup>2</sup> 冲击加速度: 500m/S <sup>2</sup> 脉冲持续时间 11ms Test time-6direction,each 3 times total 18 times 测试次数-6个方向, 各3次共计 18次  	Contact resistance : 100mΩ max 接触电阻: 100 mΩ 以下 Insulation resistance: 100MΩ min 绝缘电阻: DC. 250V, 大于 100MΩ Withstand voltage :No. destruction. 耐电压: 无绝缘破坏。 No.2.2.1 to 2.2.2 shall be satisfied 满足 2.2.1 到 2.2.2 项

3. Precaution 注意事项	
3.1 Soldering condition 浸焊条件	
Item 项目	Condition 测试条件
Preheat temperature 预热温度	110°C max (Embilomental temperature of soldering surface of P.C.B ) 110°C 以下 (印刷基板焊锡周围的温度)
Preheat time 预热时间	60 sec, max 60 秒以内
Area of flux 助焊剂面积	1/2 max of P.C.B. thickness 印刷基板厚度的 1/2 以内
Temperature of solder 焊锡温度	260±5°C max 260±5°C 以下
Times of immersion 浸焊时间	Within 5 sec 5 秒以内
Soldering number 浸焊次数	1 times 1 次
Printed wiring board 印刷基板	Single sided copper- clad laminates 单面铜箔
<p>1) After switches were soldered, please be careful not to clean switches with solvent 开关浸焊后, 注意不要用溶剂清洗。</p> <p>2) In the case of using soldering iron, soldering conditions shall be 280°C max and 3 sec max. 在使用烙铁的情况下, 焊锡温度应在 280°C 以下、3 秒以内。</p> <p>3) Right after switches were soldered; please be careful not to load on the knobs of switches. 浸焊后, 注意不要在手柄顶部施加负荷。</p> <p>3.2 Design instructions (设计中应注意事项)</p> <p>1) Follow recommended P.C.B. piercing plan in the outside drawing page. 印刷基板的安装孔尺寸参见产品图</p> <p>3.3 Note (注意点)</p> <p>1) Please be cautious not to give excessive static load or shock to switches. 注意不要施加超过负荷的压力或晃动开关。</p> <p>2) Please be careful not to pile up P.C.B. after switches were soldered. 开关焊接以后, 印刷基板注意不要叠放。</p> <p>3) Preservation under high temperature and high humidity or corrosive gas should be avoided especially. When you need to preserve for a long period, do not open the carton. 保管时尤其应注意避开高湿高温和有腐蚀性气体的环境, 如需长时间保存, 请不要打开包装箱。</p> <p>4) SMT 焊接时, 刷锡厚度应控制在 0.13mm 以内。 SMT were soldered., thickness control 0.13mm MAX</p>	

## 4. Specification 材质

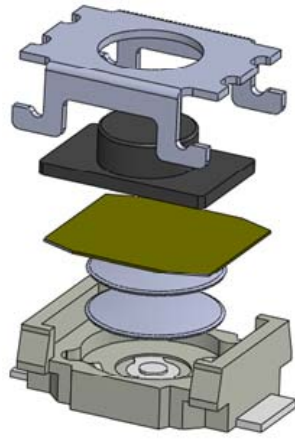
NO	Part Name 名称	QTY 数量	Material 颜色	Specification 材质	Photos 照片
1	盖板	1	本色	不锈钢/接地镀银	
2	按钮	1	黑色	LCP	
3	薄膜	1	黄色	聚酰亚胺	
4	簧片	2	本色	不锈钢覆银	
5	基座	1	白色	LCP	
6	端子	1	银白色	磷铜镀银	

## 5.Reel page 编带尺寸 (4000pcs/盘)

